

STRAMIT® CUSTOM PRODUCTS

ROOFING PANELS

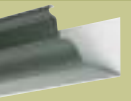

GUTTERING



RAINWATER HEADS



DOWNPIPES



ASTRAGALS



ROOF VENTS



LOUVRES





Custom Roofing Page 4



Gutters Page 5



Downpipes & Astragals Page 6

SOURCE YOUR CUSTOM RAINWATER

Stramit Building Products offers a complete range of custom rainwater goods and roofing accessories to suit any architectural style.

With the acquisition of Creeks Metal Industries, Stramit Building Products inherited more than 60 years' experience in the manufacture of specialised roofing, guttering and rainwater goods.

Our skilled tradespeople can produce virtually any design to specification and they enjoy the challenge of creating new products. Detailed drawings can be faxed via your local distributor, or call your nearest Stramit office to talk to our Special Products sales team.





Roof Vents Page 7



Rainheads Page 8-15



Awnings & Louvres Page 16

GOODS FROM THE ROOFING EXPERTS.

All products can be manufactured from an extensive choice of materials, including Stramit® Premium Materials and Finishes (COLORBOND® Ultra, Stainless and Metallic coated steels, Plain Stainless, Aluminium and Copper) as well as standard COLORBOND® colours, ZINCALUME® and Galvanised.

This brochure provides a selection of designs that can be ordered by quoting the relevant number along with the required dimensions. Alternatively, the photos and drawings can be used as the basis for original designs. For further information on ordering, see the Specification section at the back of this brochure. If you have any special requirements or problems, talk to your Stramit rep.



STRAMIT. SIMPLY A BETTER ROOF

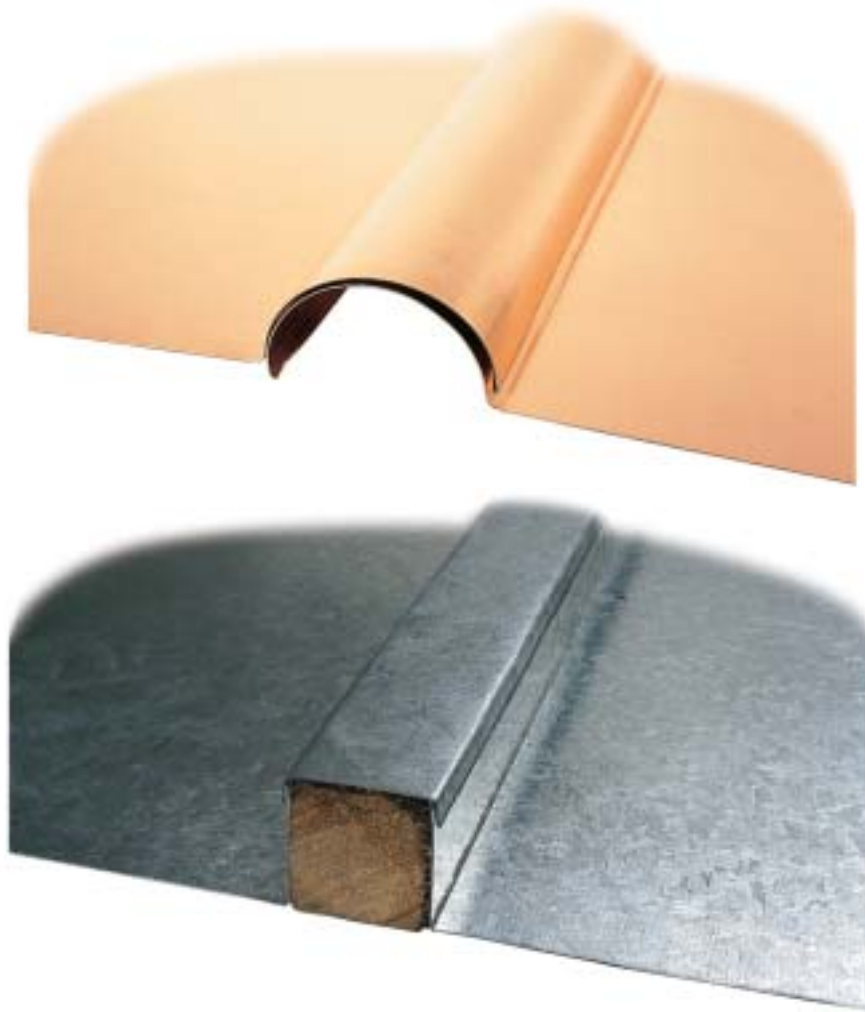

ROOFING

Design Notes:

- Flat roofing panels with custom ribs and overlaps can be produced in a range of materials to suit any project, including domestic, commercial, modern and heritage.
- Profiles can be manufactured to customer specifications or to match existing installations. Simply provide roofing sample or measurements taken on site, or contact the Stramit Special Products team.

Materials:

- COLORBOND®, ZINCALUME®, Copper, Aluminium, Pure Zinc, Galvanised.

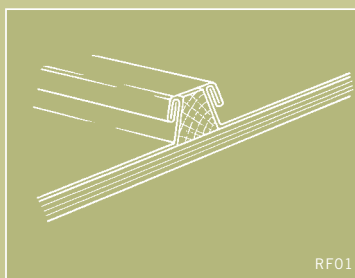

RF01

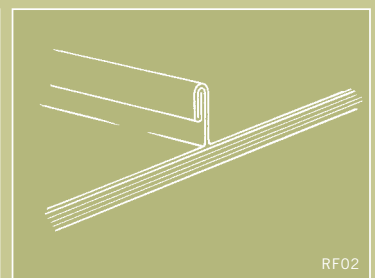

RF02

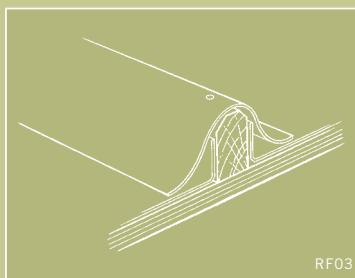

RF03

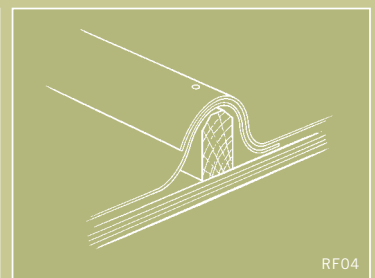

RF04



GT01



GT02



GUTTERS

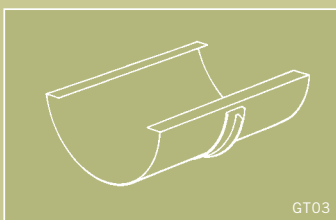

GT03

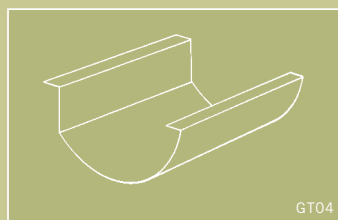

GT04

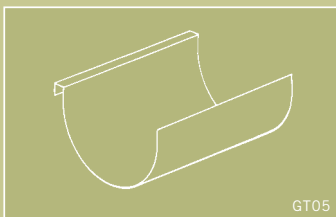

GT05

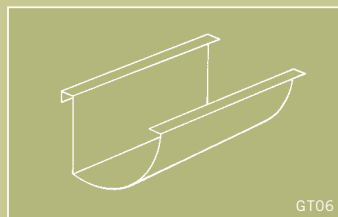

GT06

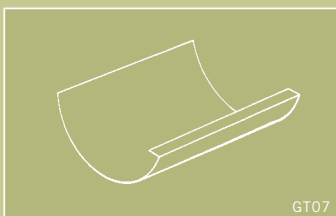

GT07

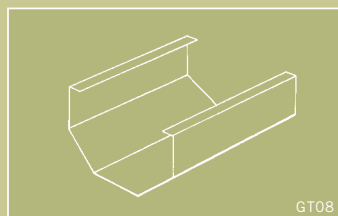

GT08

Design Notes:

- Half round, ogee and many other gutter profiles are available in sizes from 100mm to 300mm (larger sizes on request) and lengths up to 6 metres, with stop-ends, nozzles, fabricated internal/external angles, transitions, integrated rainheads and a range of brackets.
- Box gutters are also available cut to length in all materials.

Materials:

- COLORBOND®, ZINCALUME®, Copper, Stainless Steel, Aluminium, Zinc, Galvanised.





DOWNPIPES & ASTRAGALS



Design Notes:

- Downpipes can be made with many profiles in lengths up to 2.4 metres.
- The crush-folded lock seam allows downpipes to be made from any metal.
- Shoes, elbows and other fabricated shapes available to order.
- Copper astragals can be made with beading and scrolling to match existing heritage astragals. Provide samples or detailed drawings.
- Larger diameters (175mm and larger) maximum length 1.8m

Materials:

- COLORBOND®, ZINCALUME®, Copper, Stainless Steel, Aluminium, Zinc, Galvanised.

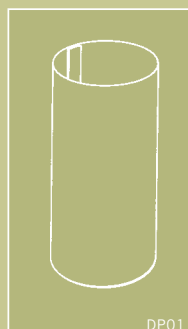

DP01

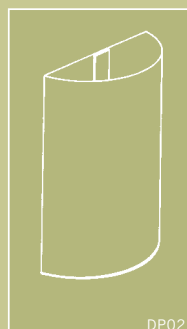

DP02

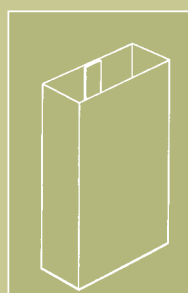

DP03

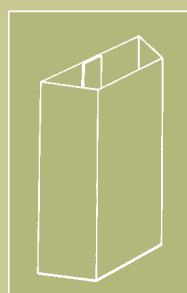

DP04

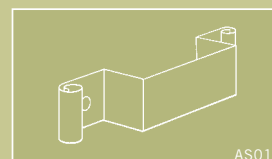

AS01

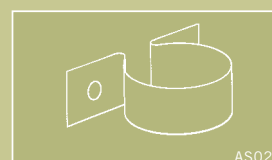

AS02

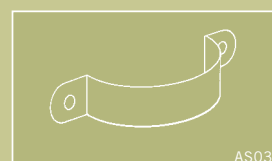

AS03

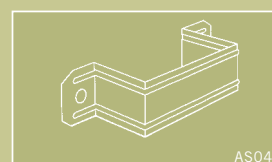

AS04



ROOF VENTS & FINIALS

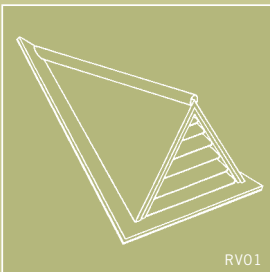

RV01

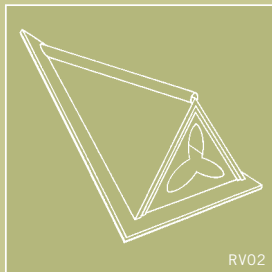

RV02

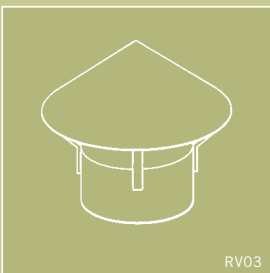

RV03

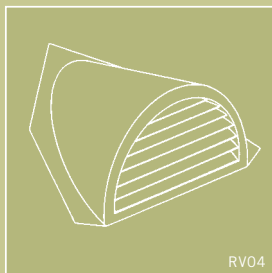

RV04

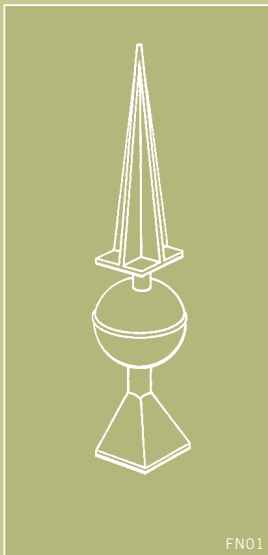

FN01

Design Notes:

- Roof vents, dormers and finials can be made to any specification in most materials.
- Provide detailed drawings or talk to our Special Products team about the design possibilities.

Materials:

- COLORBOND®, ZINCALUME®, Copper, Stainless Steel, Aluminium, Zinc, Galvanised.





RAINWATER HEADS [TRADITIONAL • HERITAGE]

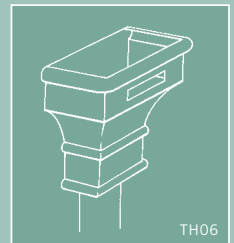
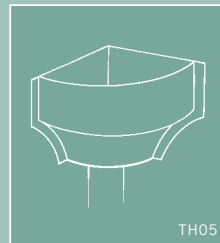
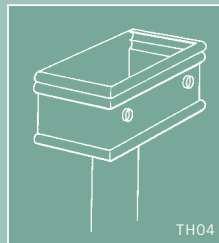
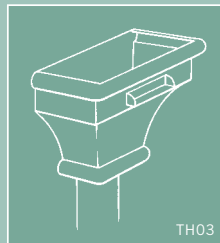
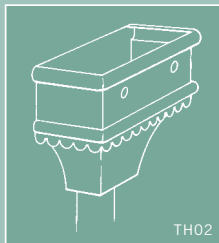
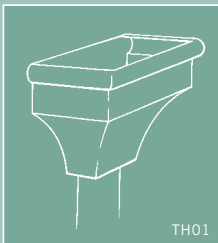

Design Notes:

- The rainhead shown here must be soft soldered because of the complicated detail (intersecting curved surfaces).
- Ogee rainheads and other complex designs are not recommended in Colorbond steel because of the large number of exposed rivets.
- Note that COLORBOND® and ZINCALUME® steel cannot be soldered because of the zinc-aluminium coating.



Materials:

- Copper, Stainless Steel, Zinc, Galvanised.
- Sample shown is Copper.
- Soldered rainheads can be supplied with wet coat paint in matched COLORBOND® colours.
- Rainheads with fully welded joints can be powder coated.
- Note that soldered rainheads cannot be powder coated as the solder melts in the drying oven.
- Rainheads are also available with fully welded joints in 1.2 - 2.0mm Copper, Galvanised, ZINCALUME®, Aluminium, Stainless and Mild Steel with powder coating.



RAINWATER HEADS [TRADITIONAL • FEDERATION]

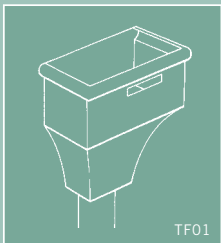

TF01

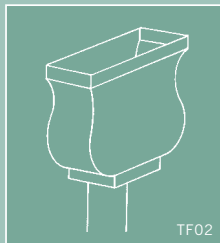

TF02

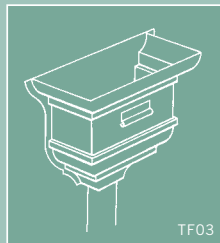

TF03

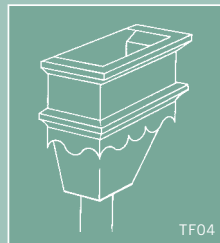

TF04

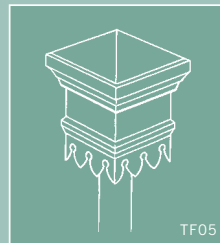

TF05

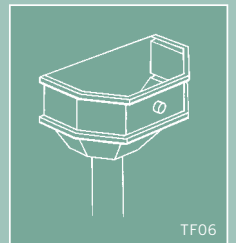

TF06

Design Notes:

- The rainhead shown here must be soldered because of the complicated detail.
- Complex designs are not recommended in COLORBOND[®], steel because of the large number of exposed rivets (COLORBOND[®] and ZINCALUME[®] steel cannot be soldered).



Materials:

- Copper, Galvanised, Stainless Steel, Zinc.
- Sample shown in Galvanised.
- Soldered rainheads can be supplied with wet coat paint in matched COLORBOND[®] colours.
- Also available with fully welded joints in 1.2 - 2.0mm Copper, Galvanised, ZINCALUME[®], Aluminium, Stainless Steel or Mild Steel with powder coating.





RAINWATER HEADS [TRADITIONAL • DECO]

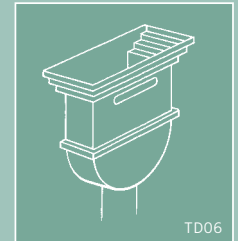
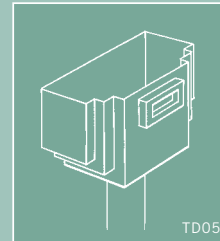
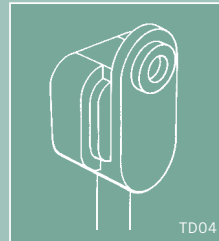
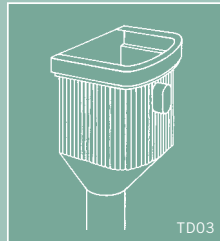
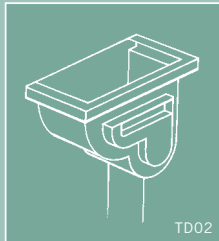
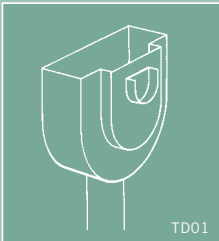

Design Notes:

- The rainhead shown here can be made in COLORBOND® steel because joins between curved and flat surfaces are suitable for riveting.
- More complex shapes (such as intersecting curved surfaces) must be soldered because of the large number of rivets required.
- Note that COLORBOND® and ZINCALUME® steel cannot be soldered because of the zinc-aluminium coating.



Materials:

- Copper, Stainless Steel, Zinc, Galvanised.
- Sample shown is COLORBOND® steel (Deep Ocean®).
- Soldered rainheads can be supplied with wet coat paint in matched COLORBOND® colours.
- Also available with fully welded joints in 1.2 - 2.0mm Copper, Galvanised, ZINCALUME®, Aluminium, Stainless Steel or Mild Steel with powder coating.



RAINWATER HEADS [CONTEMPORARY • FLAT-FACED]

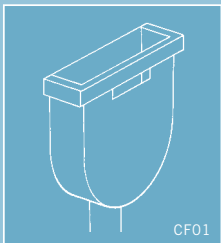

CF01

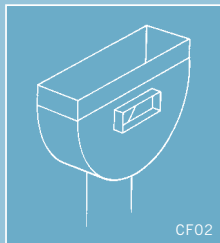

CF02

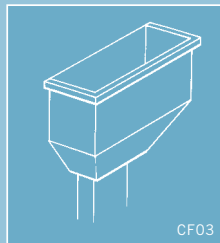

CF03

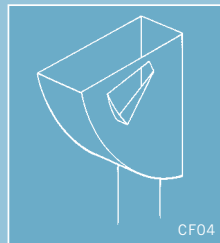

CF04

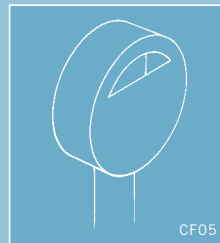

CF05

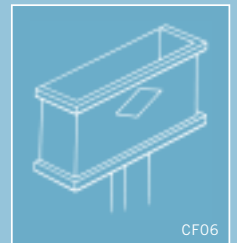

CF06

Design Notes:

- The rainhead shown here is an ideal design for COLORBOND® steel because joins between curved and flat surfaces are suitable for riveting and sealing.
- Some shapes illustrated with complex detailing must be soft-soldered because of the large number of rivets required.
- COLORBOND® and ZINCALUME® steel cannot be soldered.



Materials:

- COLORBOND®, ZINCALUME®, Copper, Stainless Steel, Zinc, Galvanised.
- Sample shown is COLORBOND® steel (Cottage Green™).
- Soldered rainheads can be supplied with wet coat paint in matched COLORBOND® colours.
- Also available with fully welded joins in 1.2 - 2.0mm Copper, Galvanised, ZINCALUME®, Aluminium, Stainless Steel or Mild Steel with powder coating.





RAINWATER HEADS [CONTEMPORARY • CYLINDRICAL]

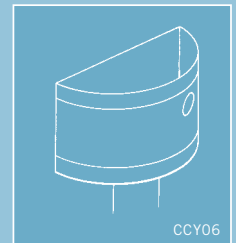
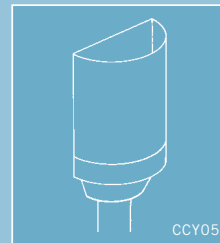
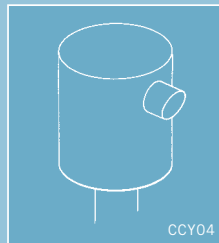
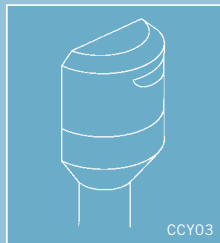
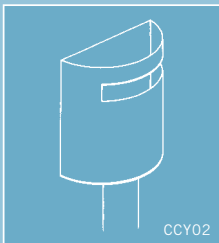
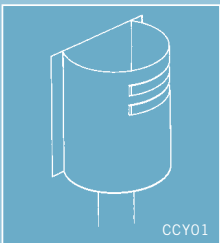

Design Notes:

- The rainhead shown here is ideal for COLORBOND® steel because joints between curved and flat surfaces are suitable for riveting and sealing.



Materials:

- COLORBOND®, ZINCALUME®, Copper, Stainless Steel, Zinc, Galvanised.
- Sample shown is COLORBOND® steel (Woodland Grey™).



RAINWATER HEADS [CONTEMPORARY • CONICAL]

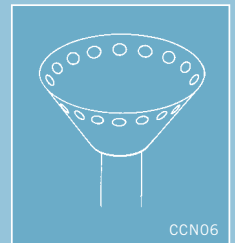
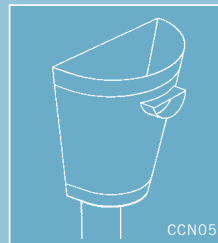
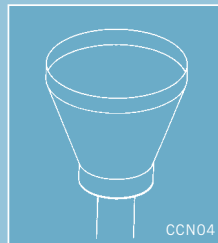
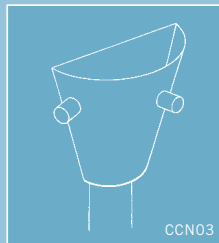
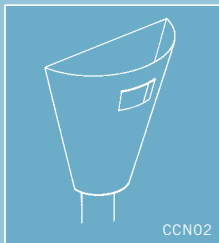
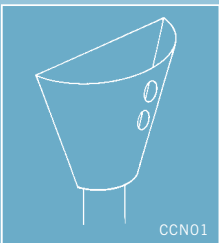

Design Notes:

- The rainhead shown here is ideal for COLORBOND® steel because joins between curved and flat surfaces are suitable for riveting and sealing.



Materials:

- COLORBOND®, ZINCALUME®, Copper, Stainless Steel, Zinc, Galvanised.
- Sample shown is COLORBOND® steel (Headland®).





RAINWATER HEADS [CONTEMPORARY • TAPERED]

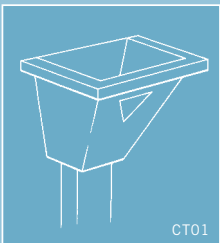

CT01

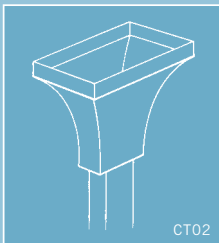

CT02

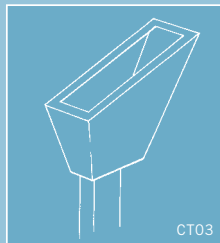

CT03

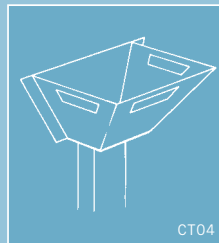

CT04

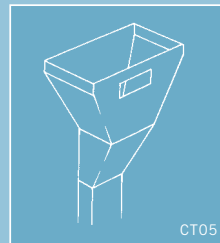

CT05

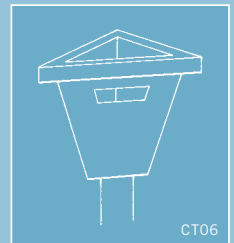

CT06



Design Notes:

- The rainhead shown here is ideal for COLORBOND® steel because joints between flat surfaces are suitable for riveting and sealing.
- Note that the curved rainhead illustrated would need to be soldered.



Materials:

- COLORBOND®, ZINCALUME®, Copper, Stainless Steel, Zinc, Galvanised.
- Sample shown is Stainless Steel.



RAINWATER HEADS [CONTEMPORARY • INTEGRATED]

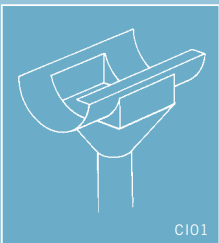

CI01

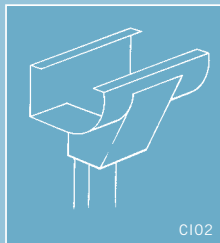

CI02

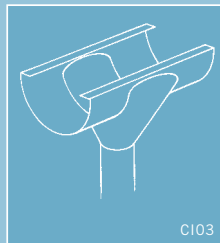

CI03

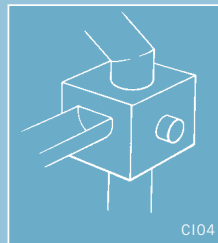

CI04

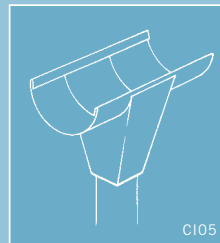

CI05

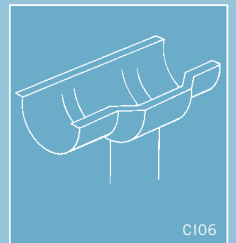

CI06

Design Notes:

- Gutters with integrated rainheads can be produced in COLORBOND® steel because the joints can be riveted and sealed with silicone.



Materials:

- COLORBOND®, ZINCALUME®, Copper, Stainless Steel, Zinc, Galvanised.
- Sample shown is COLORBOND® steel (Paperbark™).



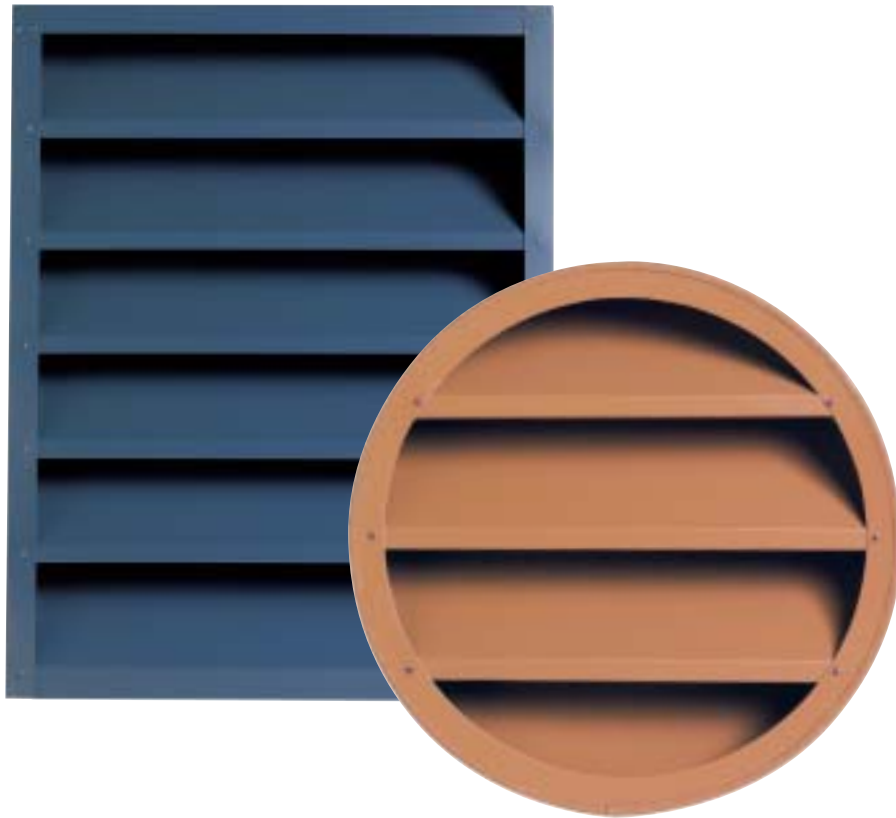

AWNINGS & LOUVRES



Design Notes:

- Window awnings and louvered wall vents can be made to order in most materials.
- Provide detailed drawings or talk to Stramit about the design possibilities.

Materials:

- COLORBOND®, ZINCALUME®, Copper, Stainless Steel, Aluminium, Zinc, Galvanised.
- Samples shown are COLORBOND® steel (Deep Ocean® & Cotta Sand)

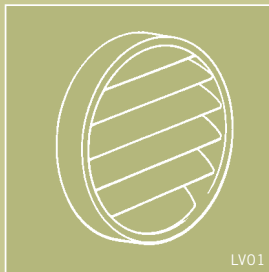

LV01

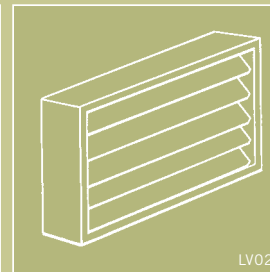

LV02

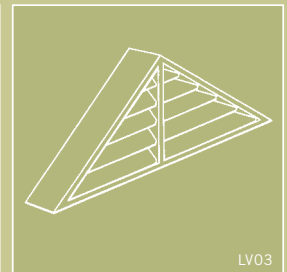

LV03

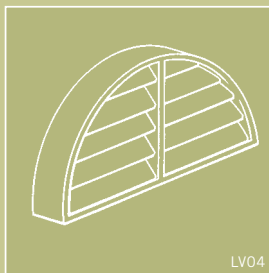

LV04

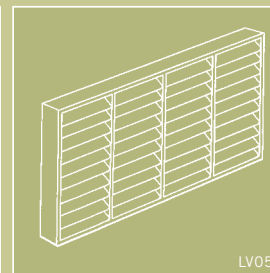

LV05

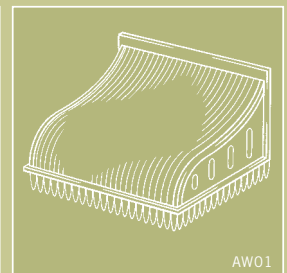

AW01

MATERIAL SELECTION

In selecting materials, consider appearance (both short and long term), durability, compatibility, capacity and sizing, design limitations (see below) and any special needs (e.g. copper is unsuitable for collecting potable water).

SELECTION CRITERIA

ZINCALUME®	Benign environments (non-coastal, non-industrial)
GALVANISED	As above
COLORBOND®	As above/wide range of colours
COLORBOND® ULTRA	Moderate to severe environments/durability
COLORBOND® STAINLESS	Severe and corrosive environments
COLORBOND® METALLIC	Superior finish with lustrous surface
COPPER	Prestige finish/long life
PLAIN STAINLESS (3162B)	Severe environments/appealing finish
ALUMINIUM	Economical alternative for severe environments
ZINC	Special conditions and environments

Contact Stramit for more information on material selection

MATERIAL COMPATIBILITY

Exercise caution when placing different materials adjacent to each other. Compatibility is an important issue where water flows from one material to another (especially from copper to other metals).

Stramit Building Products has the expertise to help with material selection and design advice. Talk to the Stramit Special Products sales team or contact your nearest Stramit branch for a copy of the Stramit® Premium Materials & Finishes Design Guide.

DESIGN LIMITATIONS

When specifying materials for rainwater goods with complex shapes, such as rainwater heads, vents and dormers, the following design limitations should be kept in mind.

COLORBOND® & ZINCALUME®: Materials with zinc-aluminium coatings cannot be soldered; they must be joined with rivets and then sealed. Complex details such as intersecting curved surfaces are difficult to rivet. Therefore, ogee rainheads and other complex designs are not recommended in COLORBOND® steel because of the large number of exposed rivets. Note that joins between curved and flat surfaces are suitable for riveting.

Copper, Stainless Steel, Zinc, Galvanised: These materials can be soldered and are suitable for complex designs, including intersecting curved surfaces.

Finishing: Soldered products cannot be powder coated as the solder melts in the drying oven. Soldered products can be finished with wet coat paint in matched COLORBOND® colours. Products with welded joints are suitable for powder coating.

Welded joins: Custom products are available in heavier gauges (1.2 - 2.0mm) with fully welded joints. Materials suitable for welding include Copper, Galvanised, ZINCALUME®, Aluminium, Stainless and Mild Steel. Galvanised, Aluminium and Mild Steel products can be powder coated in matched COLORBOND® colours.

ORDERING & SPECIFICATION

Custom roofing and rainwater goods can be ordered from your Stramit representative, local Stramit office or distributor. For expert advice, unusual product requests or on-site measuring, contact the Stramit Special Products sales teams in Brisbane, Sydney and Melbourne.

To specify a product, you will need to supply a detailed drawing or a reference to the Product Number in this brochure, with dimensions. To match existing products, samples can be left with your Stramit sales rep or distributor.

ORDERING RAINWATER HEADS

Stramit supplies two standard rainwater heads (Square and Ogee) in two sizes (small and large). The dimensions are:

STANDARD HEAD [SMALL] 380 wide x 175 high x 200 deep

STANDARD HEAD [LARGE] 450 wide x 250 high x 250 deep

Note: The dimensions for standard heads do not include nozzle height. All rainheads illustrated in this brochure are available in a standard size of 450mm wide by 250mm deep by 320mm high.

Ogee HEAD [SMALL] 310 wide x 200 deep

Ogee HEAD [LARGE] 400 wide x 250 deep

Note: Height of Ogee heads must be specified.

TO ORDER CUSTOM RAINHEADS, PLEASE SUPPLY:

1. Detailed drawing showing front and side elevations
2. Material and gauge
3. Colour
4. Quantity
5. Nozzle size, with location clearly marked
6. Contact name, phone and fax numbers

Requests for quotes can be placed with Stramit offices or distributors. A quote will be faxed back to the number supplied, showing price, lead time and a Quote Number. To ensure your order is processed quickly, please include the Quote Number on the final order.

HOW TO ORDER CUSTOM RAINHEADS Supply a detailed drawing with dimensions as shown below.

Square

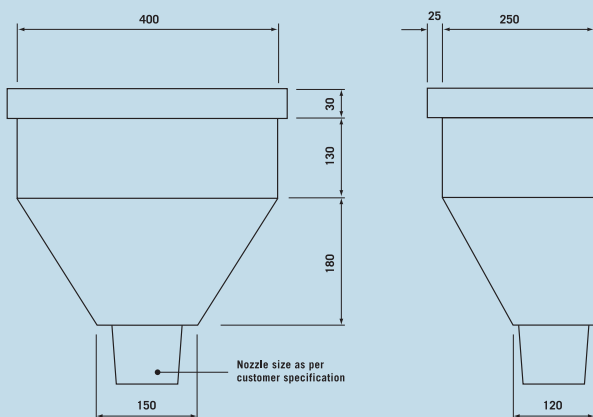

Ogee

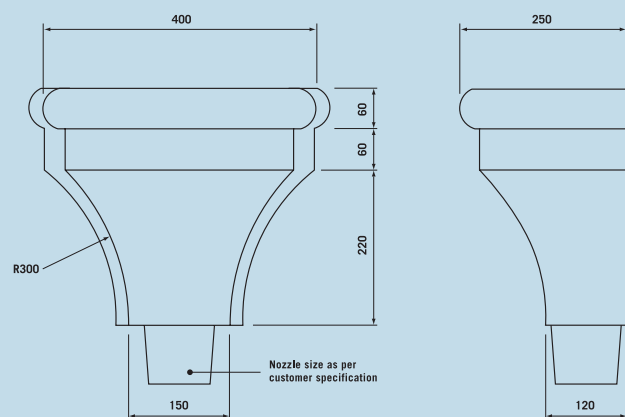

Photocopy this page for quotation requests. Please included detail drawings showing front and side elevations.

STRAMIT CUSTOM PRODUCTS • QUOTATION REQUEST

COMPANY:	
CONTACT NAME:	
TELEPHONE:	FACSIMILE:
MOBILE:	EMAIL:
PRODUCT NUMBER AND DESCRIPTION:	

	
---	--

For rainwater heads, please include nozzle size with position clearly marked.

MATERIAL:	GAUGE:
QUANTITY:	COLOUR:

SPECIAL INSTRUCTIONS:	
-----------------------	--

INTERNAL USE ONLY	Received by:	
	Attention:	
	Estimate:	
QUOTE NUMBER:		

STRAMIT BUILDING PRODUCTS REGIONAL OFFICES

Sydney

33-83 Quarry Road, Erskine Park NSW 2759
Telephone (02) 9834 0900
Facsimile (02) 9834 0988

Canberra

4 Bass Street, Queanbeyan NSW 2620
Telephone (02) 6297 3533
Facsimile (02) 6297 8089

Coffs Harbour

6 Mansbridge Drive, Coffs Harbour NSW 2450
Telephone (02) 6652 6333
Facsimile (02) 6651 3395

Newcastle

17 Nelson Road, Cardiff NSW 2285
Telephone (02) 4954 5033
Facsimile (02) 4954 5856

Orange

51 Leewood Drive, Orange NSW 2800
Telephone (02) 6361 0444
Facsimile (02) 6361 9814

Melbourne

2/1464 Ferntree Gully Rd, Knoxfield VIC 3180
Telephone (03) 9237 6200
Facsimile (03) 9237 6299

Albury

18 Ariel Drive, Albury NSW 2640
Telephone (02) 6041 7600
Facsimile (02) 6041 7666

Bendigo

Ramsay Court, Kangaroo Flat VIC 3555
Telephone (03) 5447 8455
Facsimile (03) 5447 9677

Hobart

57 Crooked Billett Drive, Brighton TAS 7030
Telephone (03) 6263 5536
Facsimile (03) 6263 6950

Launceston

289 Hobart Road, Kings Meadows TAS 7249
Telephone (03) 6343 7390
Facsimile (03) 6343 7381

Adelaide

11 Stock Road, Cavan SA 5094
Telephone (08) 8262 4444
Facsimile (08) 8262 6333

Brisbane

57-71 Platinum Street, Crestmead QLD 4132
Telephone (07) 3803 9999
Facsimile (07) 3803 1499

Townsville

402-408 Bayswater Road, Garbutt QLD 4814
Telephone (07) 4779 0844
Facsimile (07) 4775 7155

Cairns

Vickers Street, Edmonton QLD 4869
Telephone (07) 4045 3069
Facsimile (07) 4045 4762

Mackay

Brickworks Court, Glenella, Mackay QLD 4740
Telephone (07) 4942 3488
Facsimile (07) 4942 2343

Maryborough

10 Activity Street, Maryborough QLD 4650
Telephone (07) 4121 2433
Facsimile (07) 4123 3139

Rockhampton

41 Johnson Street, Parkhurst QLD 4702
Telephone (07) 4936 2577
Facsimile (07) 4936 4603

Sunshine Coast

Unit 1, 5 Kerry St, Kunda Park QLD 4556
Telephone (07) 5456 4083
Facsimile (07) 5456 4862

Murwillumbah

6 Kay Street, Murwillumbah NSW 2484
Telephone (02) 6672 8542
Facsimile (02) 6672 6798

Darwin

55 Albatross Street, Winnellie NT 0820
Telephone (08) 8947 0780
Facsimile (08) 8947 1577

Perth

605-615 Bickley Road, Maddington WA 6109
Telephone (08) 9493 8800
Facsimile (08) 9493 8899

Bunbury

25 Proffit Street, Bunbury WA 6230
Telephone (08) 9721 8046
Facsimile (08) 9721 8017